

Walltherm detail information

Clearance requirements

Clearance requirements in the U.S. and Canada for standard parallel and corner freestanding installations:

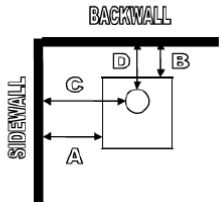

Standard residential installation with single wall connector

A. Sidewall to appliance	10.0" (254 mm)
B. Backwall to appliance	10.0" (254 mm)
C. Sidewall to connector	17.0" (432 mm)
D. Backwall to connector	13.5" (330 mm)

Walltherm dimensions - Königsspitze

Dimensions Walltherm,
model Königsspitze:

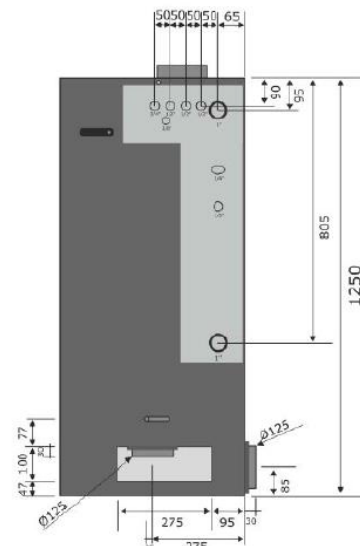
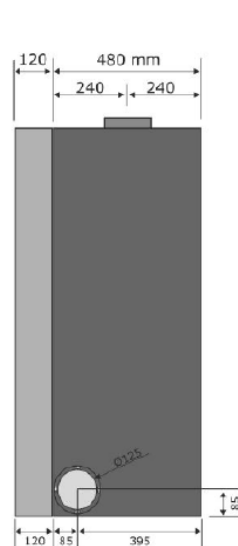
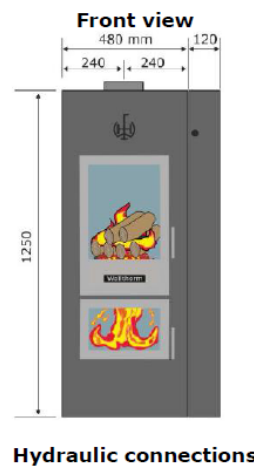
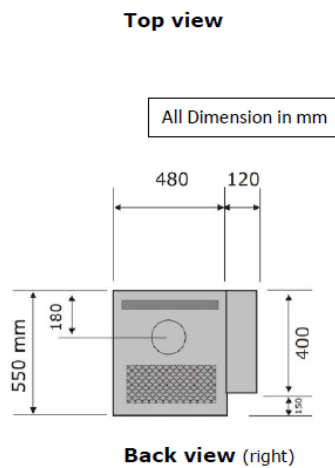

Power Strength & Energy Solutions Ltd.

Walltherm dimensions - Wilder Kaiser

Dimension Walltherm, model Wilder Kaiser:

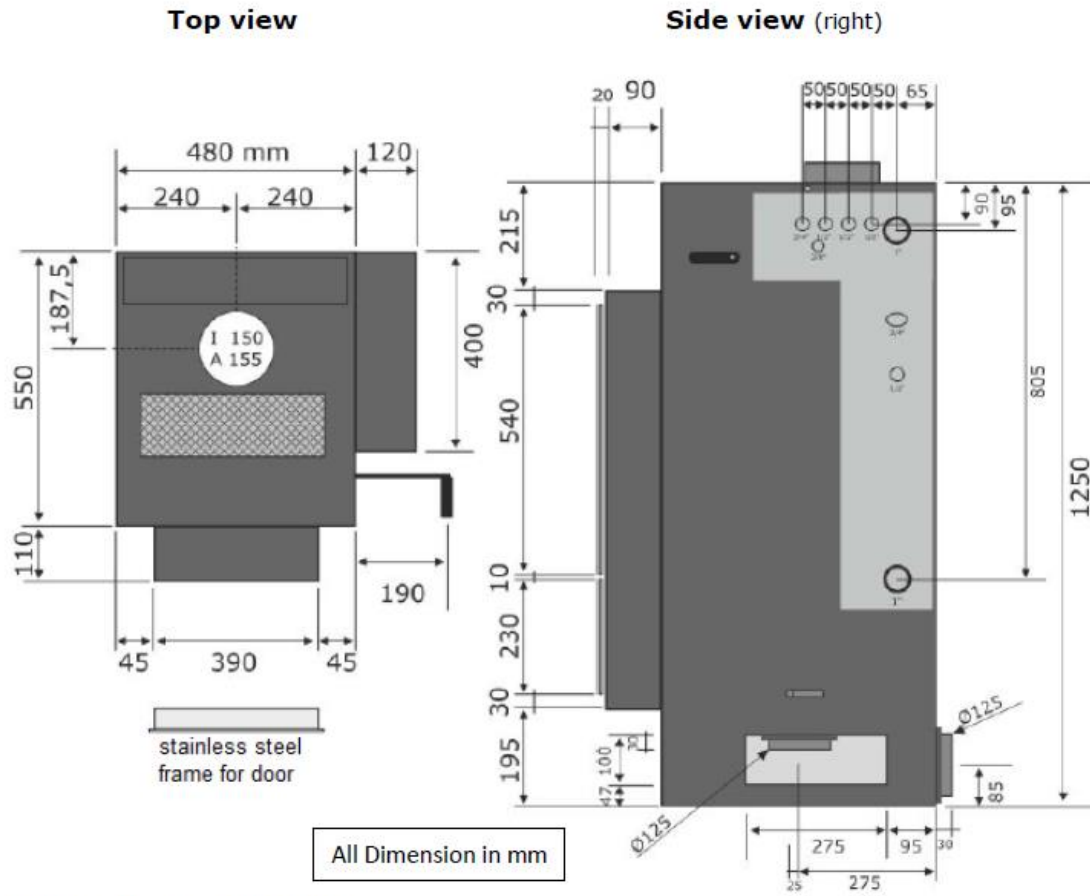

Dimensions all models

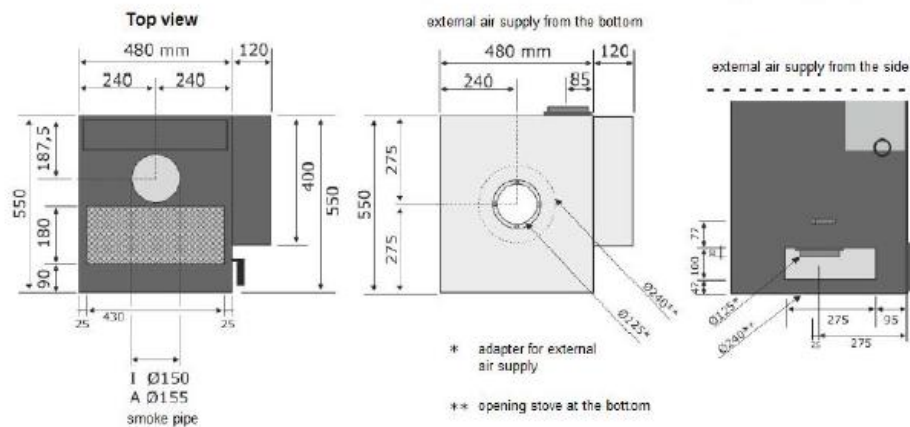

How it works

